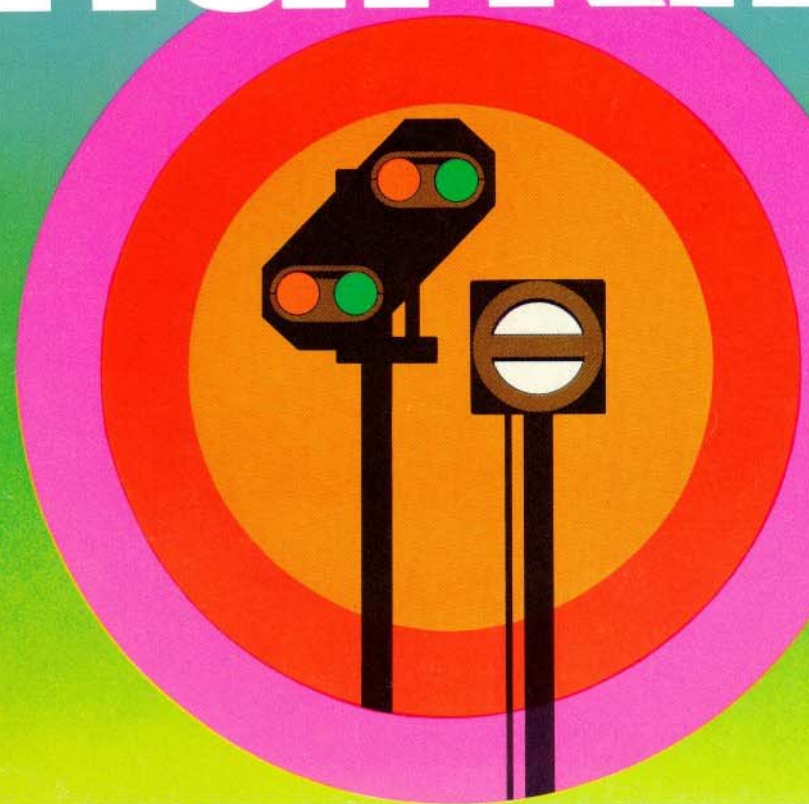




# märklin



Signal-  
buch  
für  
Signale  
7000  
7100

**M**

0340

To all fans of our  
HO gauge miniature  
railroads

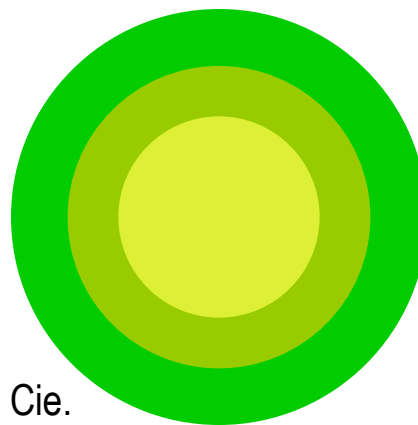
On model railroad systems which deserve the name, just as on real railroads, the use of signals to ensure safe operation is practically imperative.

We therefore decided to write this manual which deals in a detailed and easily understood way with the special features of the individual signals.

Every layout, whether large or small, can gain in realism to a high degree from the very wide selection of signals offered by Märklin.

The signals described in this manual were developed for use with metal tracks and they follow the practice on real railroads to a large extent. The foremost considerations were trouble-free operation and suitability for their applications. The traction current switches in the home signals were e.g. given silver contacts and so are capable of coping with high current loads.

For the correct installation, wiring up and operation, particularly of signals fitted with train controls, there are points to be noted, in spite of the simplicity of the Märklin system, which cannot be covered in our regular operating instructions.





## Signal location

The 7036 signals and subsequent numbers can be installed anywhere on the track **layout both on straight and on curved tracks**. They are secured firmly in place by simply pressing the track section into the signal baseplate. Where the signal unit is to be screwed on to a wooden base alongside the track, the box cover must first be removed to

allow access to the two holes for wood screws in the baseplate. Those who prefer left-hand traffic, in accordance with practice in their own countries, can also install the signals on the left-hand side of the track. The one thing to be noted is that the baseplate must be pushed on to the signal base from the correct side (fig. 1a and 1b).

Fig. 1a  
signal for right-hand traffic

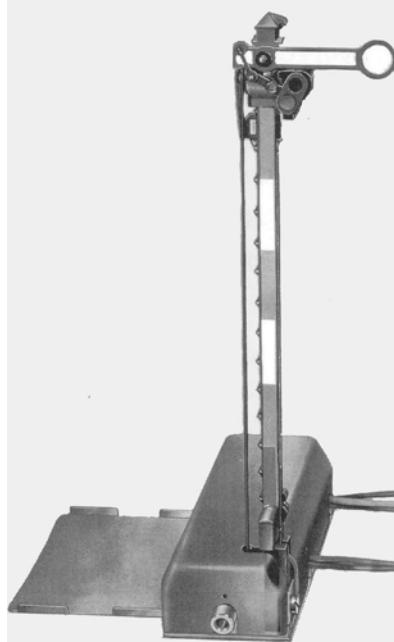
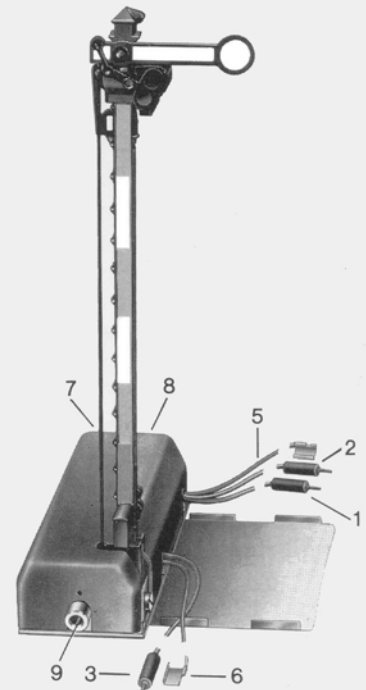


Fig. 1b  
signal for left-hand traffic



- ① yellow plug
- ② red plug
- ③ green plug
- ④ red lead
- ⑤ red lead
- ⑥ red lead



## Wiring and sockets on the signals

On all train control signals a distinction is drawn between the signal operating current and the controlled current. The appropriate connections are shown in fig. 1b for signal 7039, in fig. 2a for signal 7041 and in fig. 2b for warning signal 7038. The connecting leads are attached similarly on the other signals. The controlling current is fed to each signal through the yellow lead with yellow plug (1). It energises the solenoid coils, generating the force to set the signal. The current returns either through the blue lead with red plug (2) or the blue lead with green plug (3) or the blue lead with orange plug (4). The traction current through the track studs is controlled by the red leads (5 and 6), each end of which is fitted with a terminal tongue. They are connected to the center contact tongues of the track. For catenary operation, the plugs of the signal feeder masts, through which the overhead conductor current flows, are connected to sockets 7 and 8. The socket (9) on the end face of the signal is used for returning the lighting current to ground when no baseplate is used. Warning signals are not intended to control train movements so they are not fitted with the connections 5, 6, 7 and 8. Further details of the signal operating current circuits and the control of the traction current are given in the next two chapters.

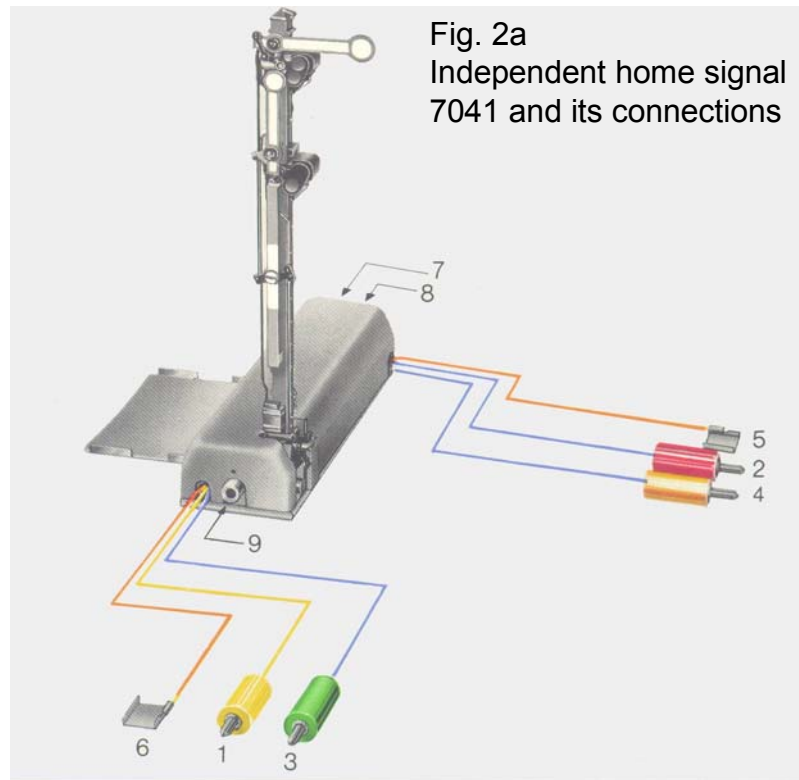


Fig. 2a  
Independent home signal  
7041 and its connections

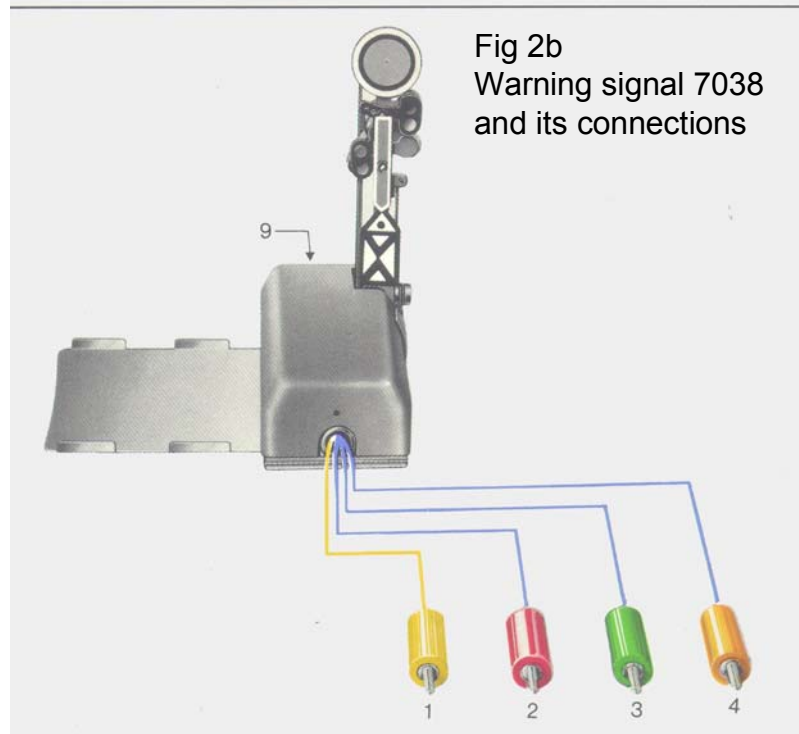


Fig 2b  
Warning signal 7038  
and its connections

## Signal operating current

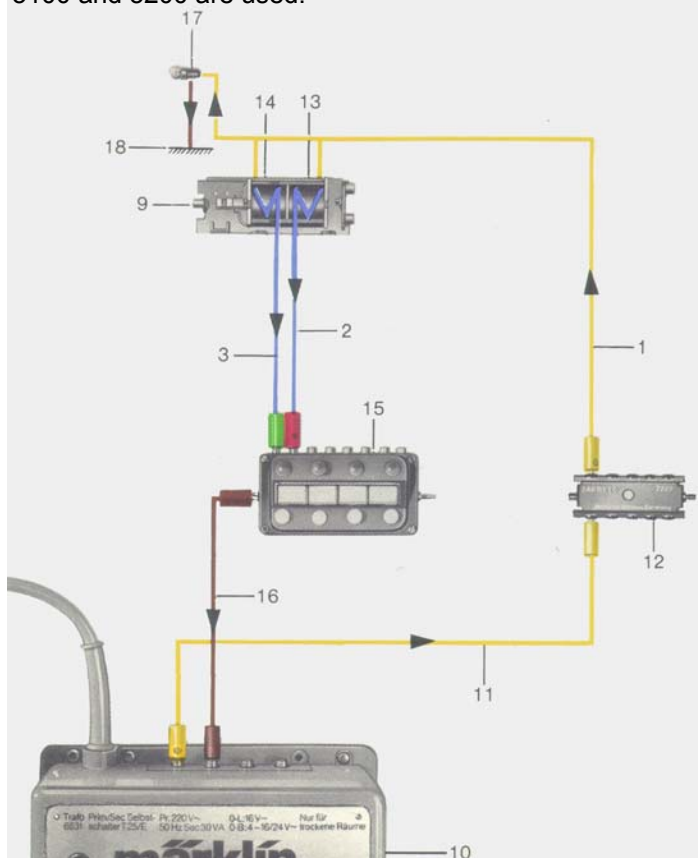
**When connected to a control panel,** The semaphore arm has two end positions and is raised or lowered by an armature. The force generated in the two solenoid coils determines the position of the armature at any time and therefore the setting of the semaphore arm. Fig. 3 shows the flow of current in these coils and the path of the signal operating current when this circuit is connected through a control panel.

The traction current connections are not shown in the diagram. The current flows from the yellow lighting socket on the transformer (10) via the lighting lead (11), the distributor panel 7209 (12) and the yellow lead (1) on the signal to the coils (13) and (14).

**Return path of the signal operating current** from coil (13) or coil (14) via a blue lead with red (2), green (3) or orange plug (4), control panel (15), ground lead (16), ground socket or transformer (10). The signal positions assigned to the separate coils are shown on page 11 and the following pages. The current for the signal lighting is carried by the yellow lead (1) to the bulb (17). The return of the current to ground is via two paths, viz.:

Fig. 3  
Circuit for the signal operating and lighting current when track sections 5100 and 5200 are used.

If the baseplate is not used, the socket (9) on the signal must be connected to ground (refer also fig. 15).

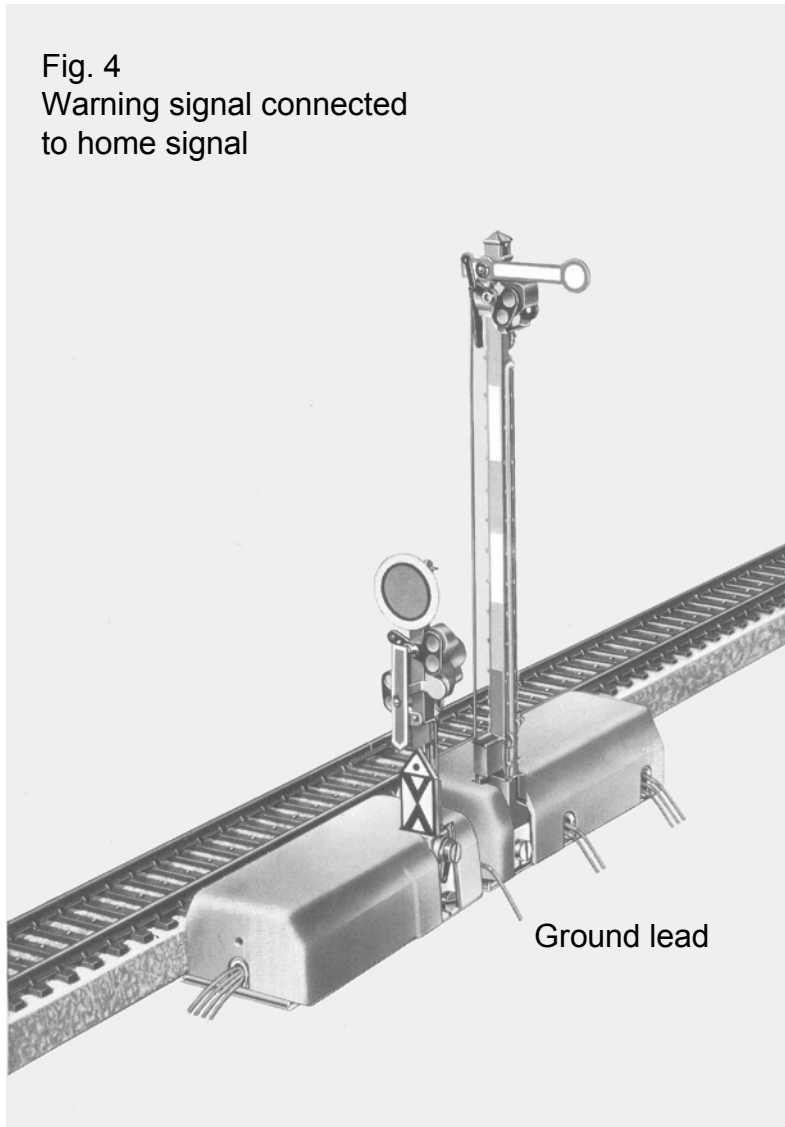


1 . With track sections 5100 and 5200 the lighting current returns to ground (18) via the signal mast and track, provided that the signal baseplate is electrically connected to the track.

2. If no baseplate is used, e.g. when signals are installed on K-tracks of the 2100 series, then the socket (9) on the end face of the signal's box cover is used for the ground connection (in some cases via a distributor panel 7209). If a warning signal is installed immediately in front of the home signal, a single ground lead is used for both signals, the two ground sockets being interconnected by a cross plug 7140 (fig.4).



Fig. 4  
Warning signal connected  
to home signal



The coils for controlling the signals and the bulbs work with the same voltage. Both are connected to the lighting current, which constitutes a considerable simplification of the circuitry. The use of a separate current supply for lighting the signal lamps was dispensed with when the signals were designed because the second lead, which would have been necessary for the lighting current, would have made the installation of the signals difficult to follow. However, if it is desired to install signal lighting which can be switched off, the baseplate forming the live connection with the track, as we saw above, can be dispensed with. In this case the signal is screwed down on to the base close up to the track and a lead is connected from the socket on the front of the signal base – leading preferably via a 7210 control panel – to the "0" socket on the transformer. If this connection is switched off at the switch panel, the signal lamp will go out but the signal itself will continue operating unimpaired.

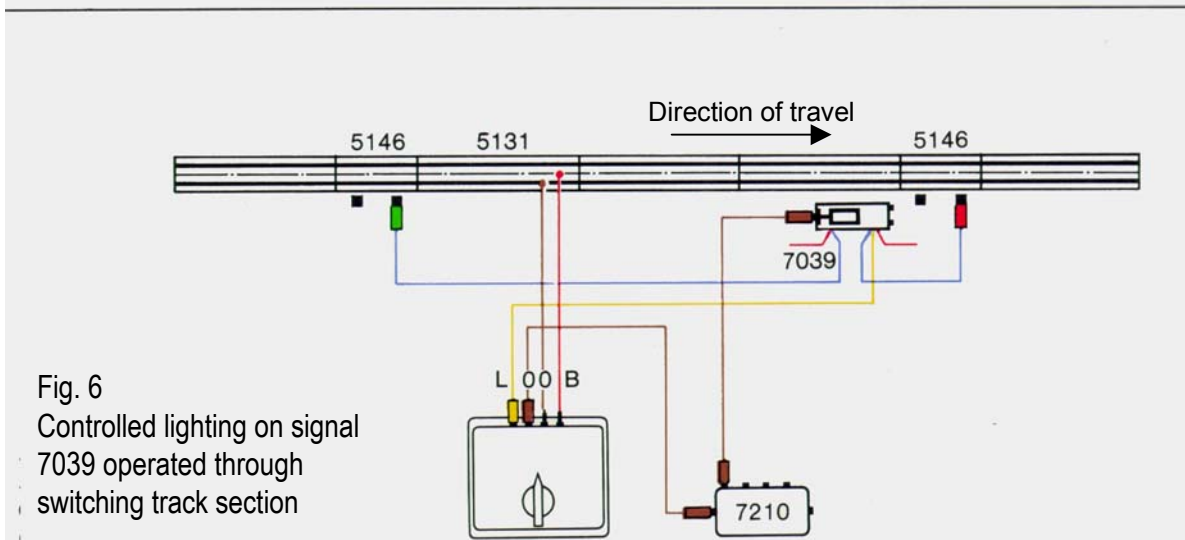
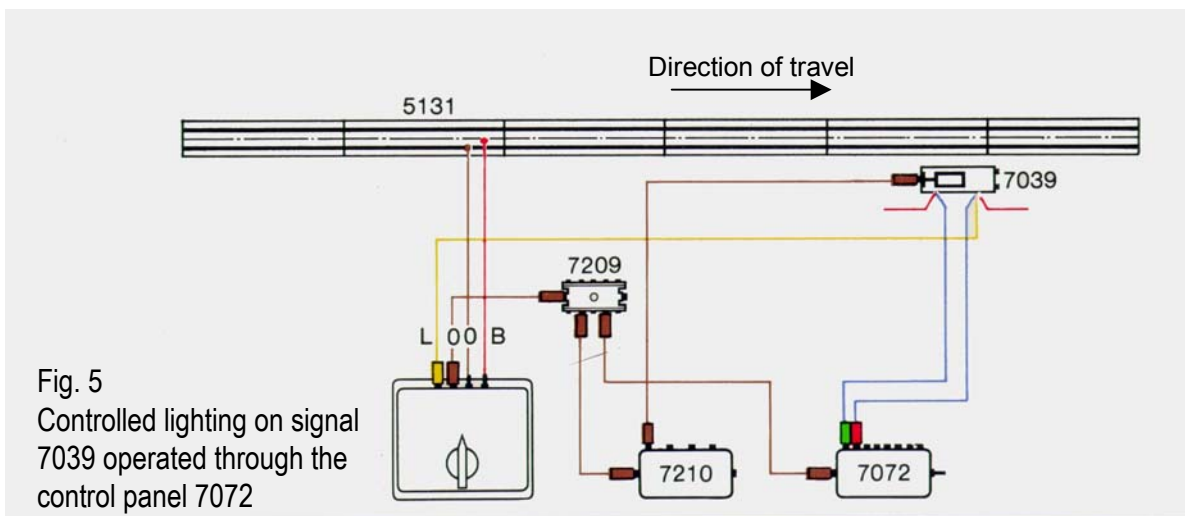
Fig. 5 and 6 show circuit diagrams for a single arm home signal 7039, controlled in one case through a control panel, in the other by the train in conjunction with switching track sections.



**The signal operating current when switching track sections are used** if the signals are to be controlled by the train in motion, switching track sections 5146, 5147 and 5213 must be used instead of the control panel. If a locomotive fitted with a pick-up shoe travels over the switching track section (fig. 7), its trip cam is rotated round its axis and one of the contact springs is pressed against a corresponding contact on the track and so grounded.

The contact remains closed as long as the pickup shoe acts on the trip arm. Because the operation of a particular contact spring is assigned to each direction of travel, different operations can be triggered off by the switching track section in each direction of travel.

It is advisable to incorporate the switching track sections in the layout in such a way that a stationary train does not remain on them for any length of time.



## Control of the traction current

If the train is to be controlled from the transformer, the traction current can be switched off at the transformer to bring the locomotive to a halt when the signal is against it. In this case the red leads to the signal must not be connected. However, if the signal is automatically to prevent the unwanted entry of the train into the track section behind it, it must be installed so as to bring the train to a halt when the signal is against it. This is achieved by arranging a particular section of track in front of the signal so that it is "dead" when the signal is against the train and "live" when the signal is open. For this purpose the signal incorporates a

**Traction current switch** which regulates the traction current as described above. The construction of the switch is shown in fig. 8a and 8b. It is coupled to the armature (1) which operates the signal arm linkage via a bell-crank level (2) (in the illustrations the signal mast has been broken down into two parts).

Separate contact plates (3) for the catenary system and the track contact studs are fitted on both sides of the armature. Two contact springs on each side slide against these contact plates (the contact springs 4 and 5 are showing in the drawing). The two red leads (6 and 7) from the signal are soldered to the two contact springs. Fig. 8a shows the switch with the circuit closed. Both contact springs (4 and 5) bear on the contact plate (3) and are thus electrically interconnected. This enables the traction current to flow from one of the red leads (6) into the other (7) (signal set at "Clear").

Fig. 8b on the other hand shows the switch in the open position. As the signal closes, the armature is pulled back, thus moving the upper silver contact spring (5) away from the contact plate (3) and pressing it against the armature (1) which is made of an insulating material. This prevents current flowing from one red lead to the other (signal set at "Halt").

Fig. 7  
Current path for switching track section

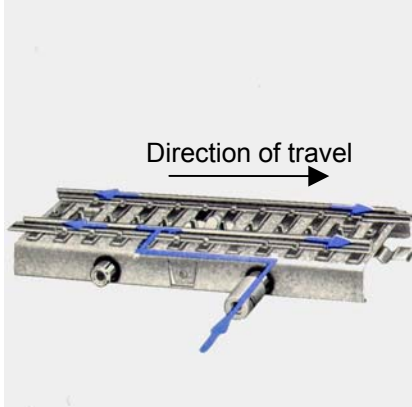


Fig. 8a  
Traction current switch in the "Clear" position

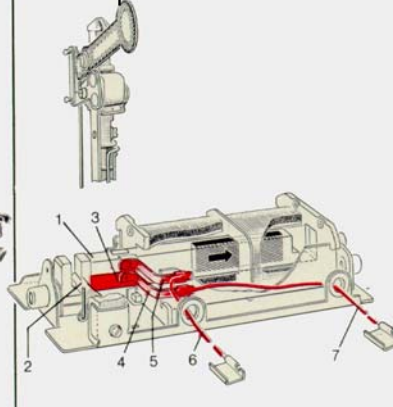
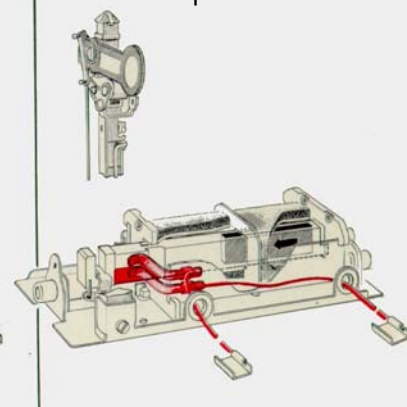


Fig. 8b  
Traction current switch in the "Halt" position





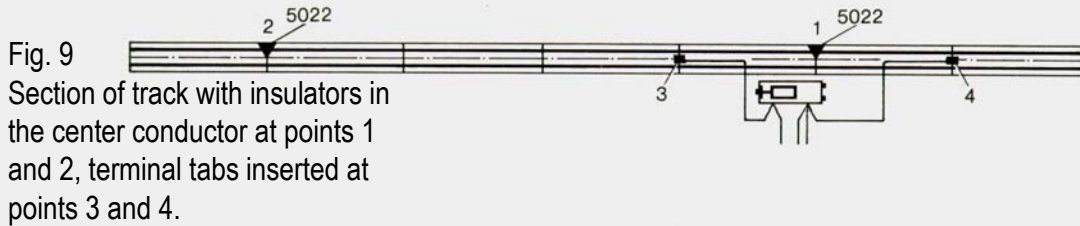


Fig. 9  
Section of track with insulators in the center conductor at points 1 and 2, terminal tabs inserted at points 3 and 4.

### 1. Using track contact studs

Fig. 9 shows the stretch of line before the signal which is electrically isolated from the rest of the circuit. Generally its length is equal to three full-length track sections. It is in this stretch of track that the train is to come to a halt. At the track section joint closest to the signal (point 1), a center conductor insulator 5022 is inserted between the tab contacts, see fig. 10. The same procedure is followed at point 2. The tabs on the two red signal leads are slipped over the contact tabs at points 3 and 4 (see fig. 10 and 11). When the signal is set at "Halt" the track situated between points 1 and 2 is dead. When the signal is set at "Clear" current flows from the terminal tab 4 to the terminal tab 3, thus supplying traction current to the line between points 1 and 2. It is advisable to mark the positions 1 and 2 of the insulators by means of insulator markers 5015 (fig. 9). The arrows visible on these small components are also used on full-scale railroad systems to indicate insulators.

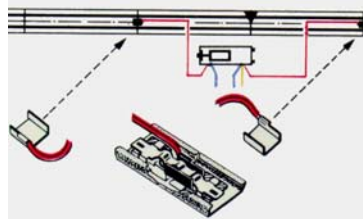
### The installation of signals for automatic switching of the traction current follows the same principle whether the track contact studs or a catenary system are used. It is very simple if the following points are noted.

Current is then fed to the isolated section via the signal feeder mast, the two red leads of which are plugged into the sockets (7) and (8) on the back of the signal base (see fig. 1b and 2a).

Fig. 10  
Fitting the center conductor insulator 5022



Fig. 11  
Fitting the contact tabs



### 2. Using the catenary system with overhead conductor suspended from mast 7009

The signal set 7005 is required for controlling the train from the catenary system. The insulators 7022 which it includes, are inserted into the overhead conductor at points in line with points 1 and 2 in the track contact stud conductor (see fig. 9).

Current is then fed to the isolated section via the signal feeder mast, the two red leads of which are plugged into the sockets (7) and (8) on the back of the signal base (see fig. 1b and 2a).

### 3. With the overhead conductor suspended between tower masts

The procedure is similar. Fig. 13 shows how the current in the overhead conductor is interrupted by suspending the conductor wire from two overhead conductor insulators 7006 arranged side by side. The insulator 7022 can be used equally well, but the catenary set 7005 is then not needed. Instead, two catenary system feeder cables 7003 are required. Fig. 14 shows how the connections are made. The catenary feeder cables (1) are plugged into the sockets (7 and 8) on the signal (see also fig. 1b and 2a), then run under the track sections to the mast (2) and along the two parallel struts of the cross span (3), after which they are fixed by means of the tab terminals (4 and 5) to the contact wire sections on the two sides of the insulator.



Fig. 12  
Connection diagram for operation from the catenary system or the track contact studs

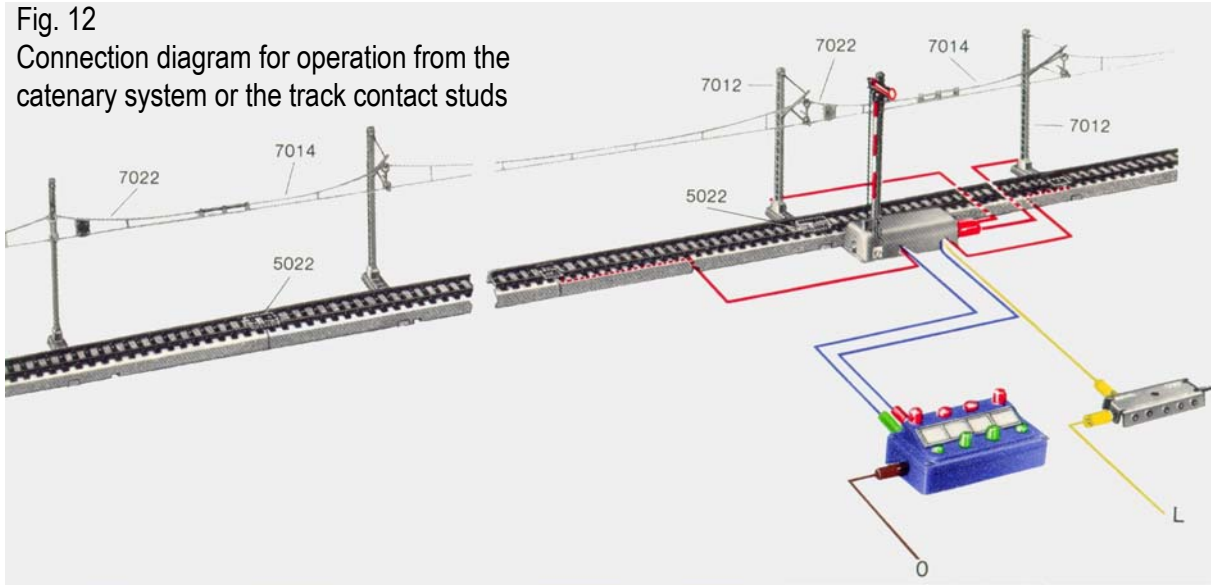


Fig. 13  
Overhead conductor current interruption by two adjacent conductor wire insulators 7006

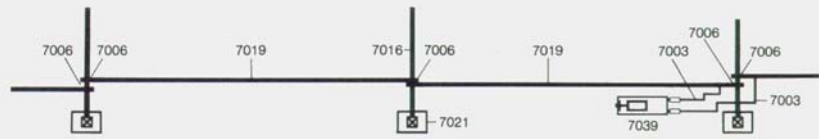
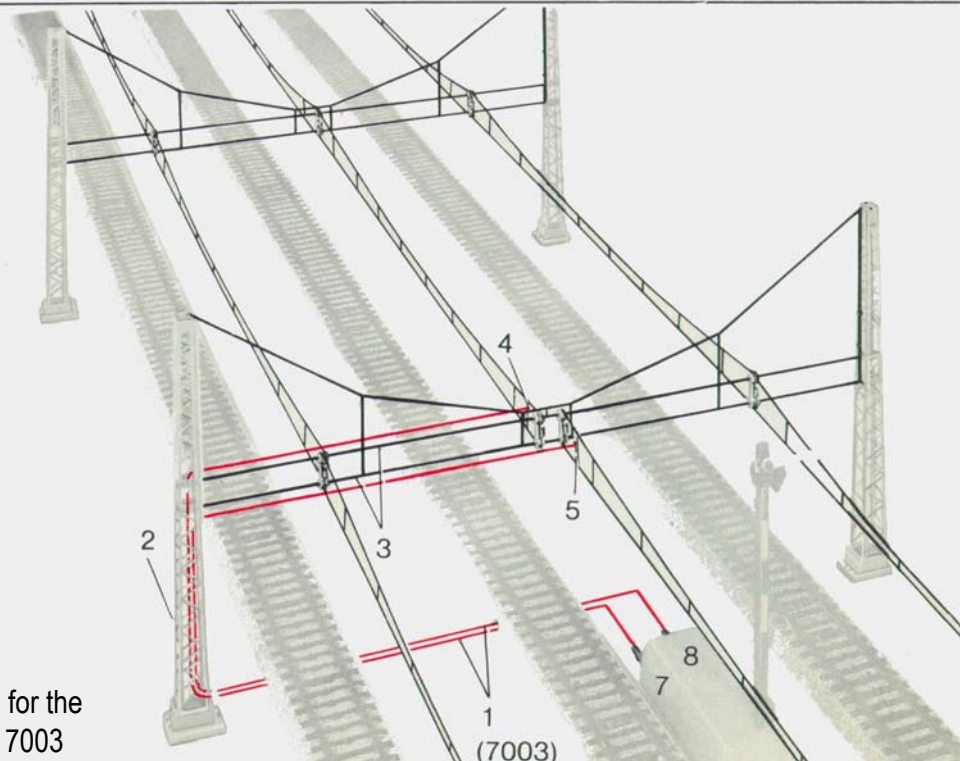


Fig. 14  
Connection diagram for the overhead conductor 7003





## Coupling warning signals with home signals

Generally the warning signals are controlled to operate in conjunction with their associated home signals. For this purpose the red plug on the warning signal's blue lead is plugged into the side socket in the red plug on the home signal's blue lead. A similar procedure is followed with the green, and where appropriate, also the orange plugs (fig. 15). If the signals

are controlled by a switching track section, the plugs of the warning and home signals are inserted into the sockets on the switching track section. Fig. 16 shows the switching track section that brings the warning and home signals to "Halt" as the train passes through.

Fig. 15  
Simultaneous operation of a warning signal and a home signal from a control panel

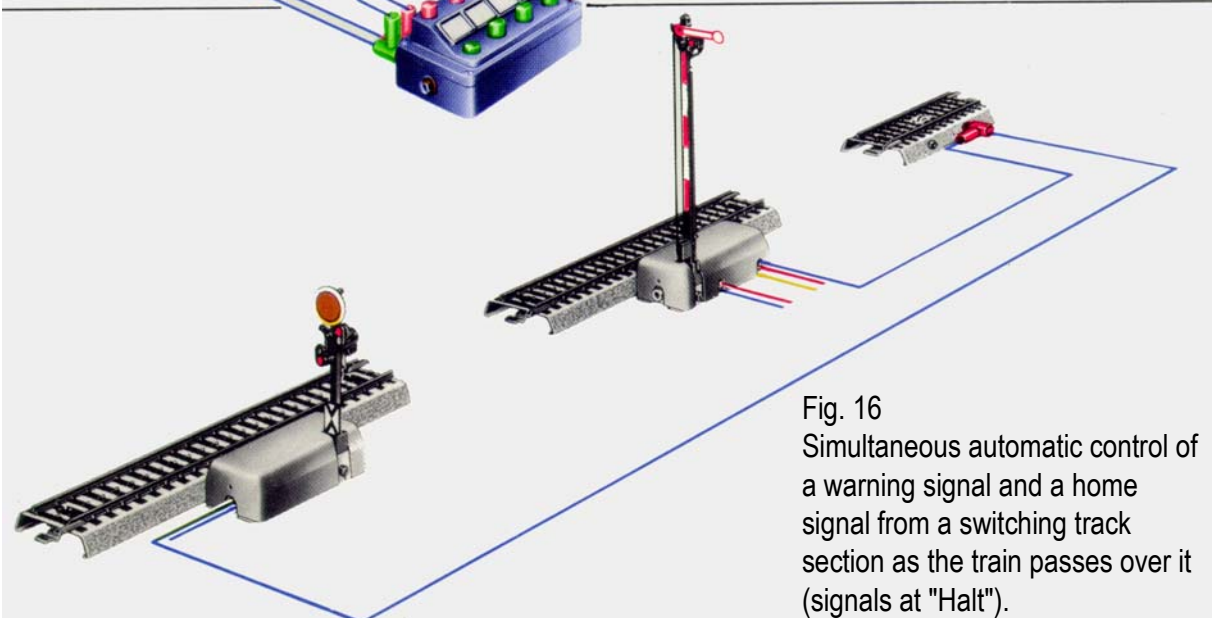
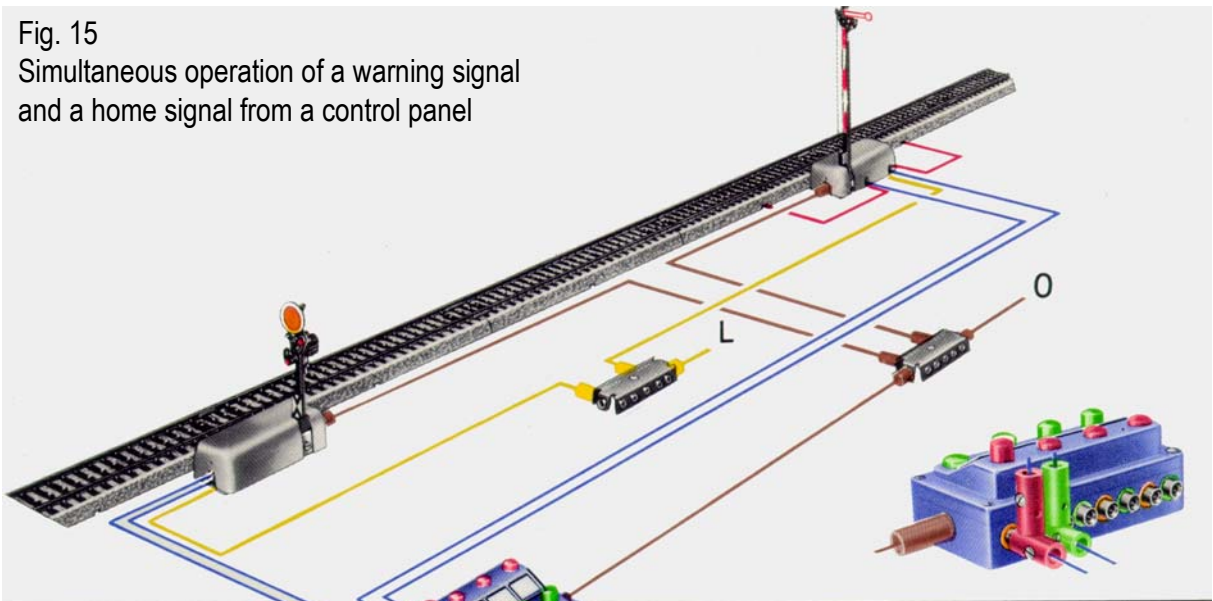


Fig. 16  
Simultaneous automatic control of a warning signal and a home signal from a switching track section as the train passes over it (signals at "Halt").



## Settings and applications of the various signals

with the code symbols used by the German Federal Railways

### 1. Warning signal 7036, home signal 7039

These signals are incorporated in the track layout where there are no turnouts behind the signal

which could divert the train from its straight course. The different possible signal settings are shown in fig. 17a to 17d.

#### Settings of home signals

Fig. 17a

**7039**



**Hp 0 "Halt"**, obtained from the blue lead with red plug

Fig. 17c



**Hp 1 "Clear"**, obtained from the blue lead with green plug

#### Corresponding settings of warning signals

Fig. 17b

**7036**



**Vr 0 "Halt signal ahead"** obtained from the blue lead with red plug

Fig. 17d



**Vr 1 "Clear signal ahead"** obtained from the blue lead with green plug



## 2. Distant signal 7038 and home signal 7040

Should the track have a turnout which **invariably** will deflect the train **from its straight course**, home signal 7040 and distant signal 7038 should be used. The distant signal has an adjustable arm as well as a movable disc. The home signal has interconnected arms, preventing independent operation of one arm only. The various signal positions in this arrangement are shown on Figs. 18a and 18b. If however, an additional straight course track is present, the signals 7038 and 7041, referred to on page 13, should be used.

### Home signal settings

### Corresponding warning signal setting

7040



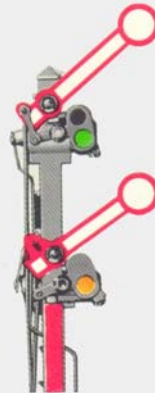
**Hp 0 "Halt", obtained from the blue lead with red plug**

7038



Fig. 18d

Fig. 18c



**Hp 2 "Slow", obtained from blue lead with green plug**



**Vr 2 "Proceed with caution", obtained from blue lead with orange plug**

### 3. Warning signal 7038 and home signal 7041

On the warning signal 7038 the extra arm **and the disk** are both **movable**. The home signal 7041 has **two arms which are not coupled together**. With these signals there are therefore three different settings which are shown in fig. 19a to 19f.

Fig. 19a

**7041**



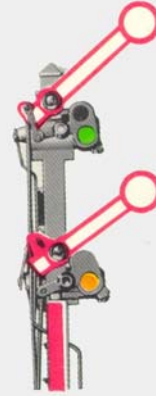
**Hp 0**  
"Halt", obtained from blue lead with red plug

Fig. 19c



**Hp 1**  
"Clear", obtained from blue lead with green plug

Fig. 19e



**Hp 2**  
"Slow", obtained from blue lead with orange plug

Fig. 19b

**7038**



**Vr 0**  
"Halt signal ahead", obtained from blue lead with red plug

Fig. 19d



**Vr 1**  
"Clear signal ahead", obtained from blue lead with green plug

Fig. 19f



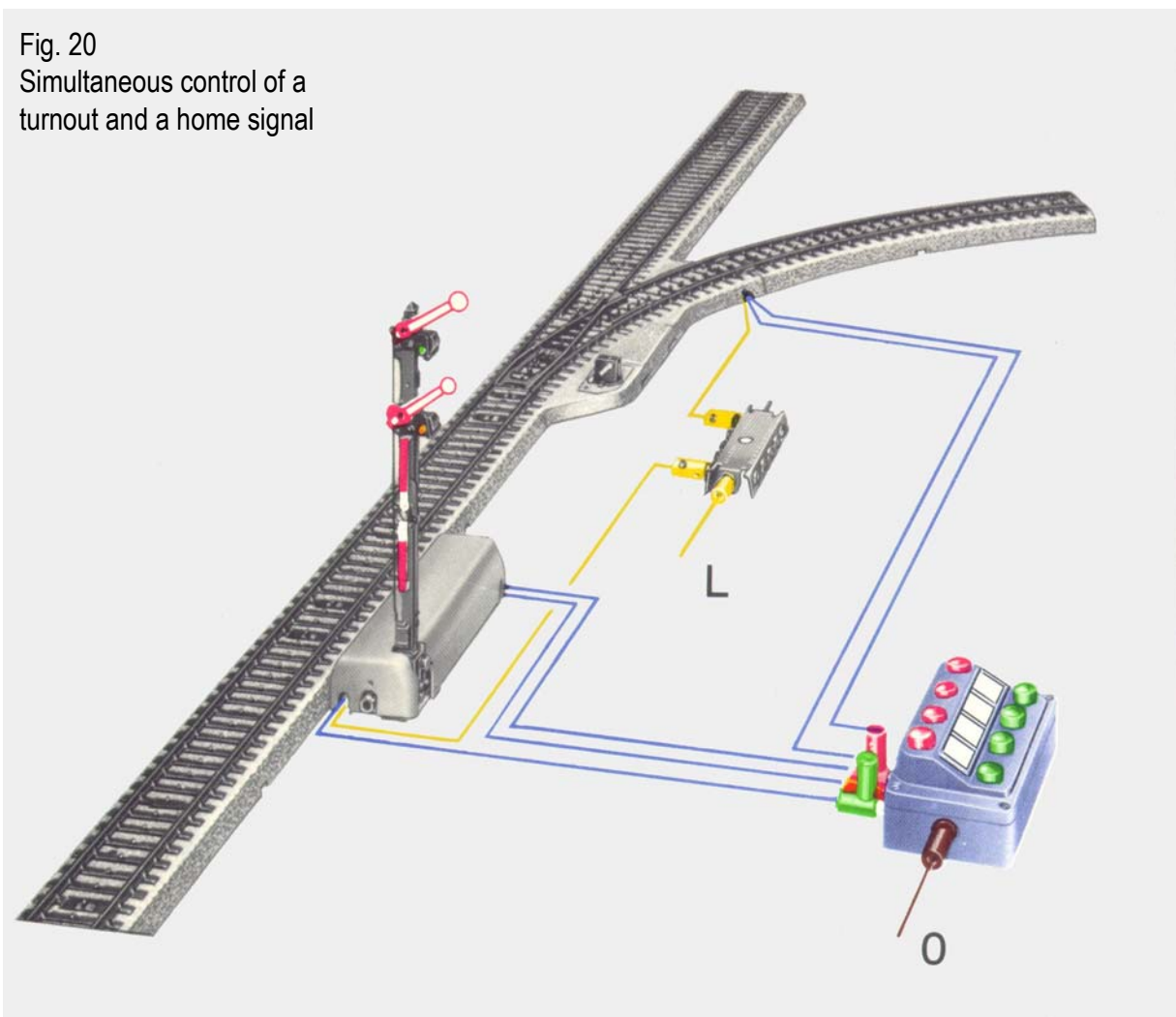
**Vr 2**  
"Proceed with caution", obtained by blue lead with orange plug



"Slow", or a speed limitation, is always necessary when the train is to be diverted from its straight course by a turnout beyond the signal. Consequently, when the signals are set as shown in fig. 19c and 19d, the train must not be led to a turnout which will divert it from its straight course. It is therefore advisable to couple the turnout which would divert the train, with the signal, so that the turnout is set simultaneously with the signal.

The coupling is achieved by inserting the turnout's green plug into the side socket in the home signal's green plug and the turnout's red plug in the side socket of the home signal's orange plug. The circuit diagram in this case is shown in fig. 20. The turnout must be set to "Straight ahead" when the signal indicates "Clear" and it must divert the train when the signal indicates "Slow".

Fig. 20  
Simultaneous control of a turnout and a home signal





## 4. Track blocking signal 7042

This signal controls shunting movement within a station. Like any other signal it can be installed by itself in proximity to the track, but it can also be installed in front of a home signal covering the exit from the station. The possible settings of the track blocking signal are shown in fig. 21a and 21b.

Fig. 21a



**Sh 0**  
"Halt", obtained from the blue lead with red plug

Fig. 21b



**Sh 1**  
"Clear to pass", obtained from the blue lead with green plug

This signal too is fitted with a switch which controls the traction current so that a locomotive cannot proceed when the signal is set at "Halt". If the track blocking signal is immediately in front of a home signal (fig. 22), it is advisable to dispense with train control by the home signal, which means that in this case only the track blocking signal's red lead is connected to the track, since the track blocking signal must also be

set at "Clear to pass" when the train leaves, i. e. not only for shunting purposes. For shunting, the home signal is set on "Halt", while the track blocking signal indicates "Clear to pass". Before the train leaves therefore the home signal must be set to "Clear" and the track blocking signal to "Clear to pass". Where no shunting is to be carried out, the two signals may be coupled together (see fig. 15).



Fig. 22  
Track blocking signal in front of a home signal at the exit from a station or yard





## 5. Light signals

Light signals are being used increasingly on railroad systems. On the German Federal Railways, newly built stations are fitted with them and several of the main lines have been modified accordingly. A new range of signals consisting of a home light signal (7188)

and a warning light signal (7187) have therefore been developed to make Marklin railroad layouts faithful copies of full-scale railroads. They are used in the same way as signals 7039 and 7036. There are the following signal settings:

### Home signal

Fig. 23a

**7188**



**Hp 0**

**"Halt "**

Fig. 24a



**Hp 0**

**"Clear "**

### Warning signal

Fig. 23b

**7187**



**Vr 0**

**"Halt signal ahead"**

Fig. 24b



**Vr 0**

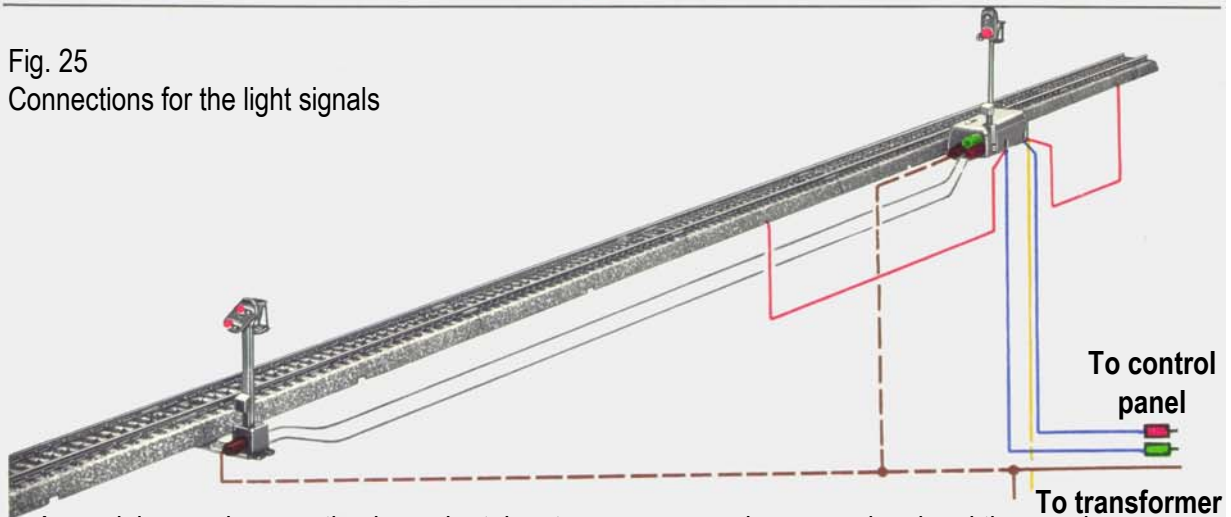
**"Clear signal ahead"**

The home signal 7188 is connected up (fig. 25) using the same color coding as for the semaphore signals described previously. It can be operated, just like the semaphore signals, either from a control panel or by switching track sections. The only difference arises with the warning signal 7187. It has no independent means of switching the lights, which are controlled by the switching of the home signal lights. The warning signal therefore has two grey leads (lights) fitted with red and green plugs respectively. These leads are plugged into the home signal's sockets marked with red and green (fig. 26).

Fig. 26  
 Connection plate for the warning  
 signal 7187 on the home signal 7188




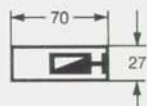



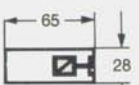


Fig. 25  
 Connections for the light signals



A special ground connection is required only when no baseplate is used. Care must

be taken to ensure a good ground connection otherwise all the lights on both the home

signal and the warning signal will be on regardless of the switch setting.

<p>(fig. 27a-h)</p> <p><b>Signal symbols</b>                  To simplify illustrations in the following layout plans the following symbols have been adopted for the different types of signals:</p>	<p>c            <b>7187</b></p>  <p><b>Warning light signal</b> functions in a similar manner to the warning signal without added arm 7036.</p>	<p>f            <b>7040</b></p>  <p><b>Home signal with two coupled arms.</b> With this signal the first arm cannot be operated by itself.</p>
<p>a            <b>7036</b></p>  <p><b>Warning signal without extra arm</b> can be used in front of the home signal 7039.</p>	<p>d            <b>7039</b></p>  <p><b>Home signal with one arm</b></p>	<p>g            <b>7041</b></p>  <p><b>Home signal with two arms not coupled.</b> Here the two arms can be moved independently of one another.</p>
<p>b            <b>7038</b></p>  <p><b>Warning signal with extra arm and movable disk</b> to be used in conjunction with home signal 7040 and 7041 or with two or more different home signals.</p>	<p>e            <b>7188</b></p>  <p><b>Home light signal</b> functions in a similar manner to the home signal with one arm.</p>	<p>h            <b>7042</b></p>  <p><b>Track blocking signal</b></p>

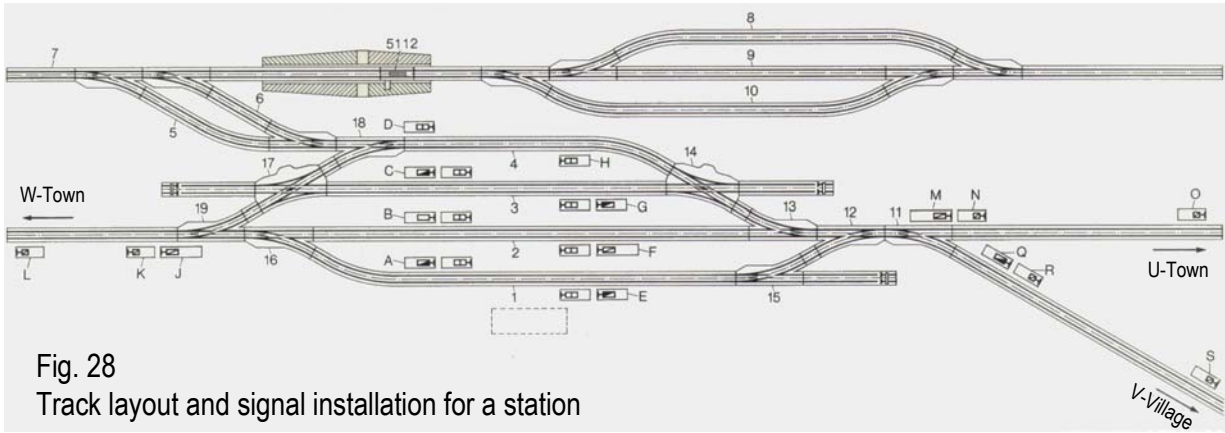


Fig. 28  
Track layout and signal installation for a station

A train arriving from the direction of U-town first passes the **warning signal O** (7038). This shows the locomotive engineer which of the following actions he must take on reaching the **home signal M** (7041)

1. Halt,
2. Continue without slowing down,
3. Pass at reduced speed.

The home signal M will not indicate "Slow" if the train is to run on to track 2, since it is not diverted by any turnout in its approach to this track, consequently the signal indicates "Clear" (fig. 19c). The engineer must reduce speed only if the train is diverted on to track 1 or 3 (or possibly track 4). In approaching track 1, the train passes over turnouts 12 and 15, in approaching track 3 the turnout 13 and the double-slip switch 14. In both cases the home signal M is set to "Slow" (fig. 19e).

The **warning signal N** (7038) at the home signal M is coordinated with the **home signals A** (7040), **B** (7039) and **C** (7040). If the train is to stop in the station, the relevant departure signal **A**, **B** or **C** will be at "Halt", as will have already been indicated to the locomotive engineer by the warning signal N, since the signal disk on the warning signal is not horizontal, nor the arm at an angle (fig. 19b).

If however the train is to pass through the station on track 2 without stopping, the warning signal disk will be horizontal, thus indicating "Clear signal ahead" at signal B.

If the train passes through the station on track 1 or track 3, only the extra arm on warning signal N will be angled at 45°, thus indicating "Proceed with caution" at signal A or C.

The situation is different with a train entering from the direction of V-village. In this case the train cannot avoid passing over the turnout 11 which diverts it from its previous track.

Consequently a home signal with two coupled arms (7040) is adequate at **point Q**. This is used in conjunction with the **warning signal S** (7038).

The **warning signal R** (7038) is intended for home signals A, B and C in the station and on this, as on warning signal N, both the disk and the extra arm are movable.

**Signals J, K and L** are subject to the same condition as signals M, N and O.

Trains leaving track 1 are diverted by the turnout 16 or the turnouts 15 and 12. Consequently home signals with coupled arms (7040) are required at **points A and E**.

Trains leaving track 2 in the direction of W-town **cannot** be diverted. Here a single-arm home signal (7039) is adequate at **point B**.

From track 2 in the direction of U-town no diversion is possible. From track 2 in the direction of V-village, the train is diverted by turnout 11. Because of these two possibilities, a home signal with independent arms (7041) must be installed at **point F**.

**Track blocking signals** are installed in front of all departure signals within the station system to safeguard platform tracks during shunting operations. For example, if the locomotive is to be changed on a train which has entered the station, it can be set into motion only when the track blocking signal indicates "Clear to pass". The associated home

signal will then be at "Halt". On the basis of these comments the reader will have little difficulty in working out the reasons for the installation of the signals which have not been mentioned.

Tracks 5 and 6 can be reached via track 4 and serve as sidings

for incoming freight trains. After the wagons have been recorded the freight train is pulled to the train assembly line 7 and then reversed over the hump. The uncoupled wagons are led into tracks 8, 9 and 10 in the gridiron siding. More details about these procedures are given in the handbook "The Märklin HO Railroads and their Originals" 0380.

## The Block System

On full-scale railway systems the stretches of track between stations are divided up into what are termed block sections, as a safety measure. At the beginning of each block section a signal is positioned which allows a train to enter the section only if the preceding train has already left it and "Halt" signal is behind it. By appropriate circuit connections the block section signals can be set to "Clear" only where no possible danger exists.

Märklin home signals enable train operating on miniature railroad systems to be safeguarded in the same way, with several trains running at the same time without risk of collision. The signals are operated fully automatically by the trains themselves.

## Layout with one signal and two trains

This system is laid out as shown in fig. 29. A switching track section, which is connected by the red plug, is installed about one train length behind the block signal, while the position of the other switching track section, into which the green plug is inserted, must be determined by trial and error. Its position depends on the difference in speed between the two trains. It is advisable to insert it for a start halfway between the center track conductor insulator 5022 and the switching track section with the red plug, on the side opposite the signal. If the two trains then appear to be on a collision course, the switching track section will have to be shifted accordingly. Operating with a single block signal and two trains does not however offer any absolute guarantee

against collision. If one train is halted or the signal is set to "Halt" by hand, collision may occur. To avoid this, three signals must be installed when there are two trains and four signals when there are three trains, i.e. there must always be one more signal than the number of trains on the layout.

## Layout with three signals and two trains

Fig. 30 shows the arrangement. It is also possible to connect the signal to be set at "Halt" to the switching track section by the red plug and the preceding signal, with respect to the direction of travel of the train, to the same switching track section by the green plug.

## Layout with five signals and four trains

The layout is similar to the one with three signals and two trains. Fig. 31 shows the details.

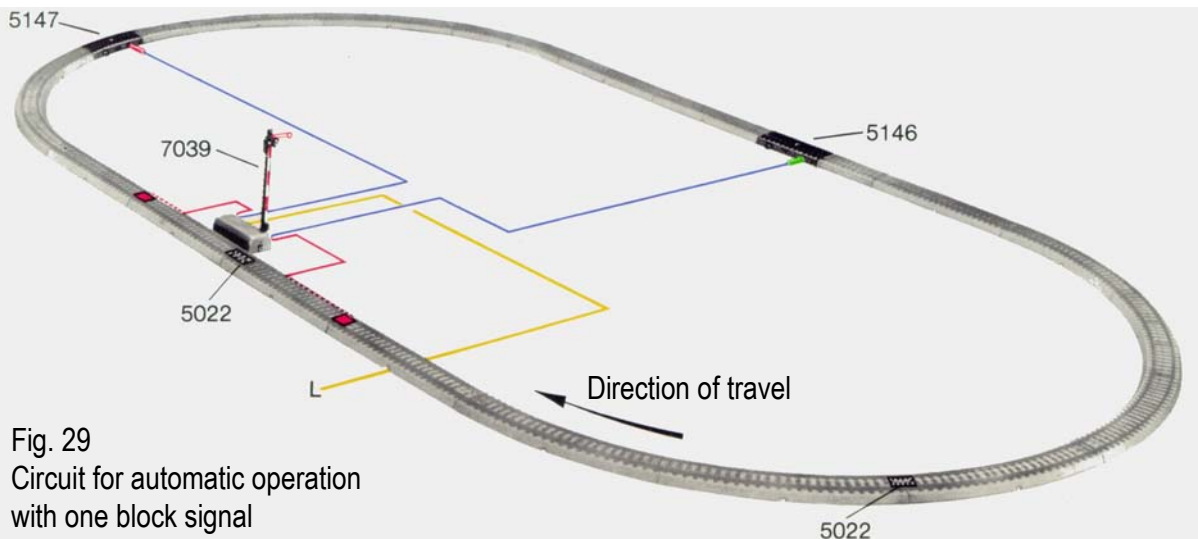


Fig. 29  
Circuit for automatic operation  
with one block signal

Layouts with even more signals and trains are assembled similarly. When there are a number of trains the load becomes too great for one transformer and two or more transformers must be used. The layout is then divided into two or more circuits with a transformer for each (fig. 31).

For the layouts shown in fig. 30, 31 and 33 it is essential to pay regard to the following points: A feeder track section or a feeder lead for the track center conductor 5004 must be allocated to each signal, since otherwise the section of track between the signals would be "dead". The feeder track

section or feeder lead is fitted between the preceding signal and the insulator 5022 in the track center conductor. This is best achieved by installing a track center conductor connection (feeder track section or feeder lead) behind each block signal and then connecting these to the traction current socket on the transformer through distributor panels 7209 (fig. 30 and 31). A short distance behind each block signal comes a switching track section which sets the signal to "Halt". The preceding block signal is connected to a further switching track section immediately adjacent to the first, in such a way that the signal is reset to "Clear" (fig. 30, 31 and 33).

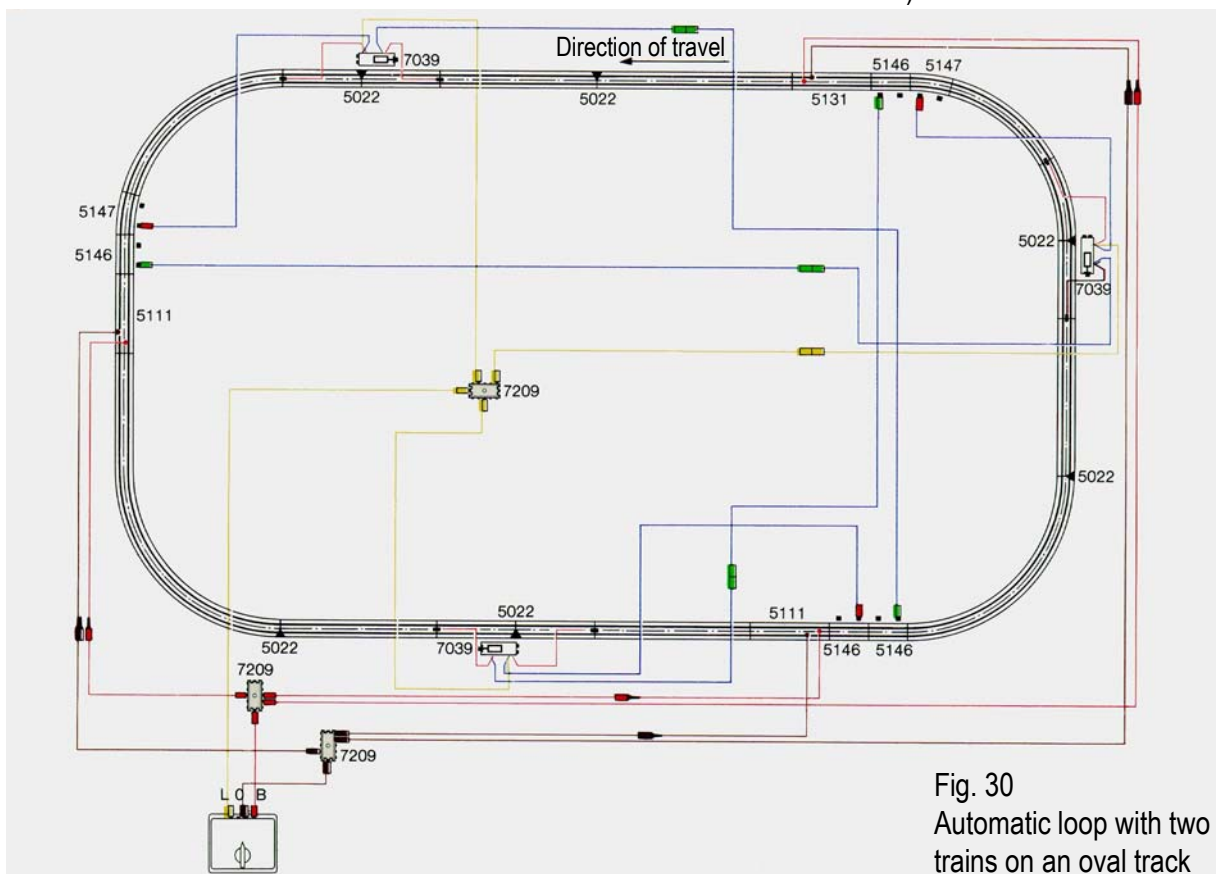


Fig. 30  
Automatic loop with two  
trains on an oval track

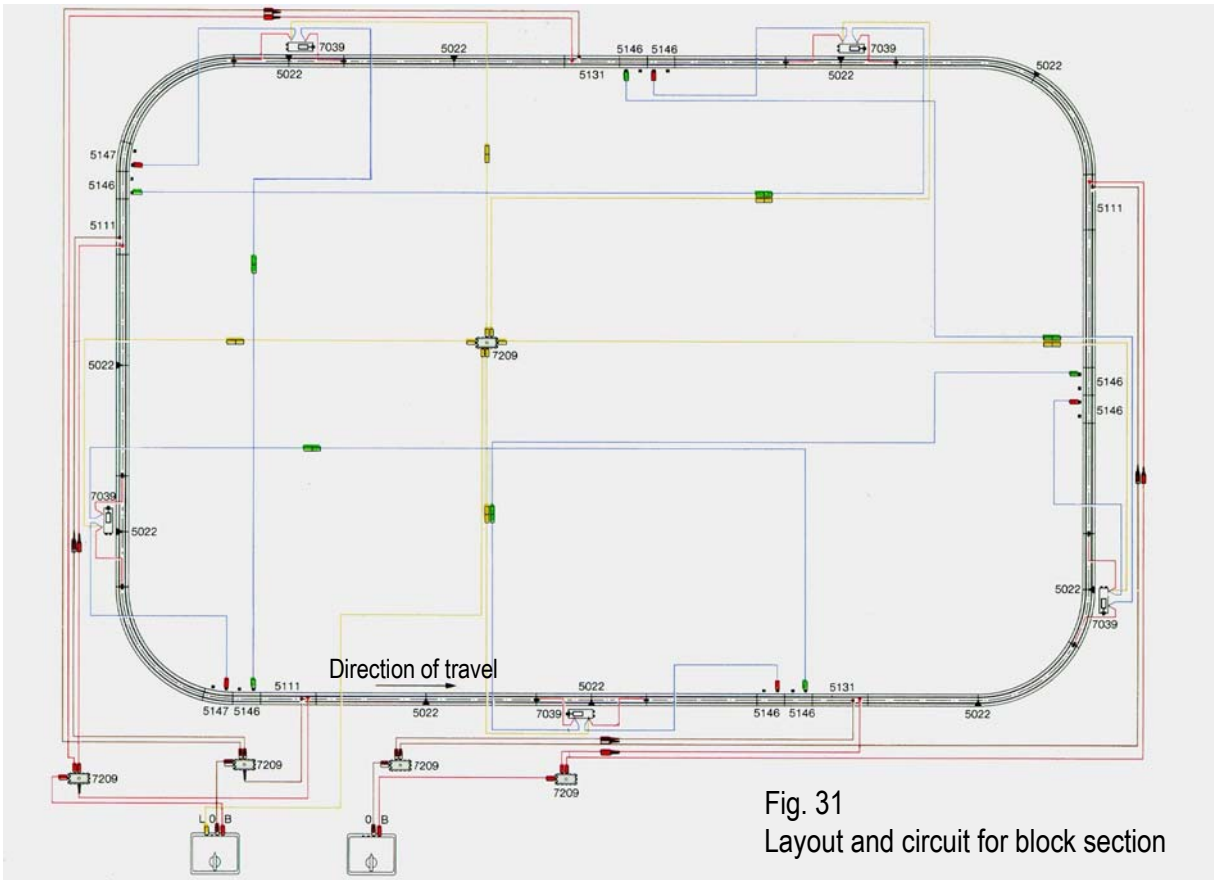


Fig. 31  
Layout and circuit for block section

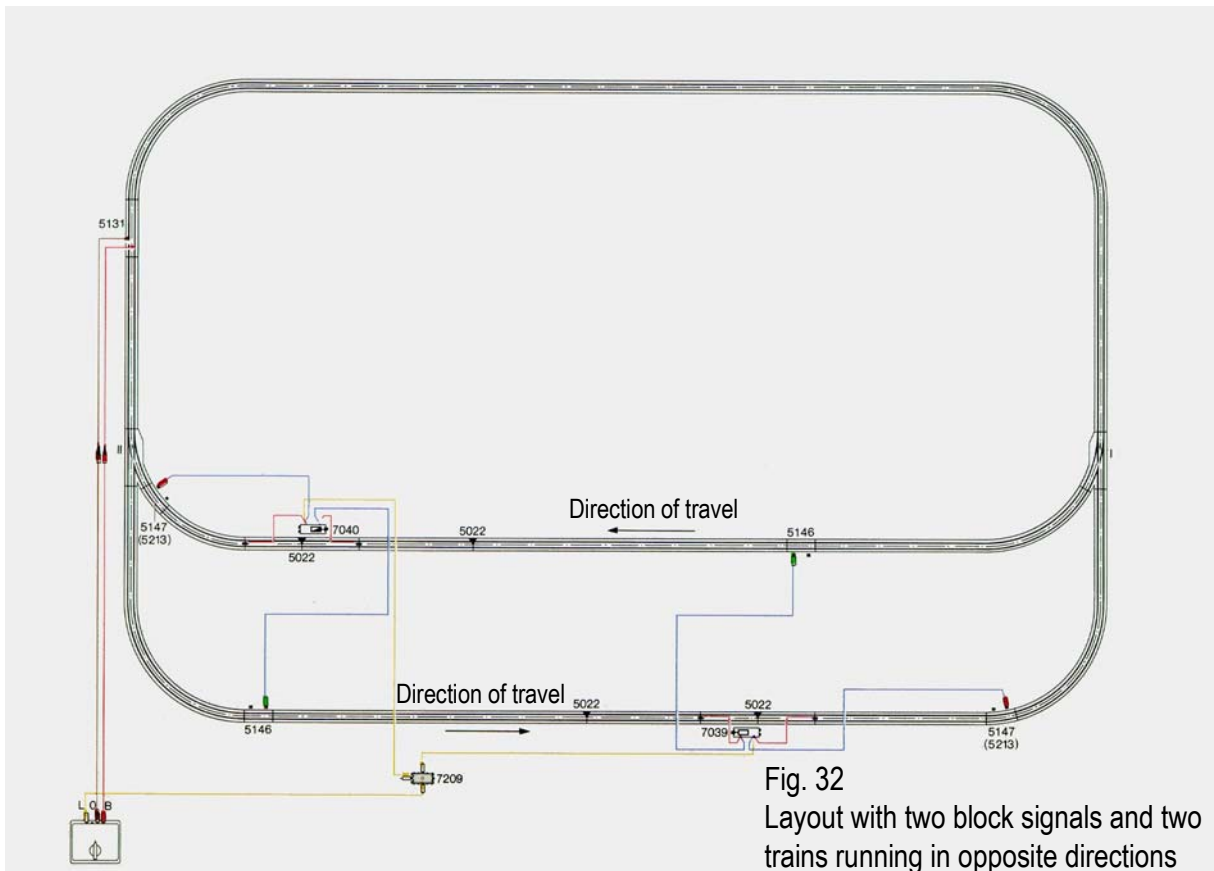


Fig. 32  
Layout with two block signals and two trains running in opposite directions



### Layout with two block signals and two trains running in opposite directions

Here the turnout I is set so that the train takes the **inner loop** whilst turnout II ensures that the train takes the **outer loop**.

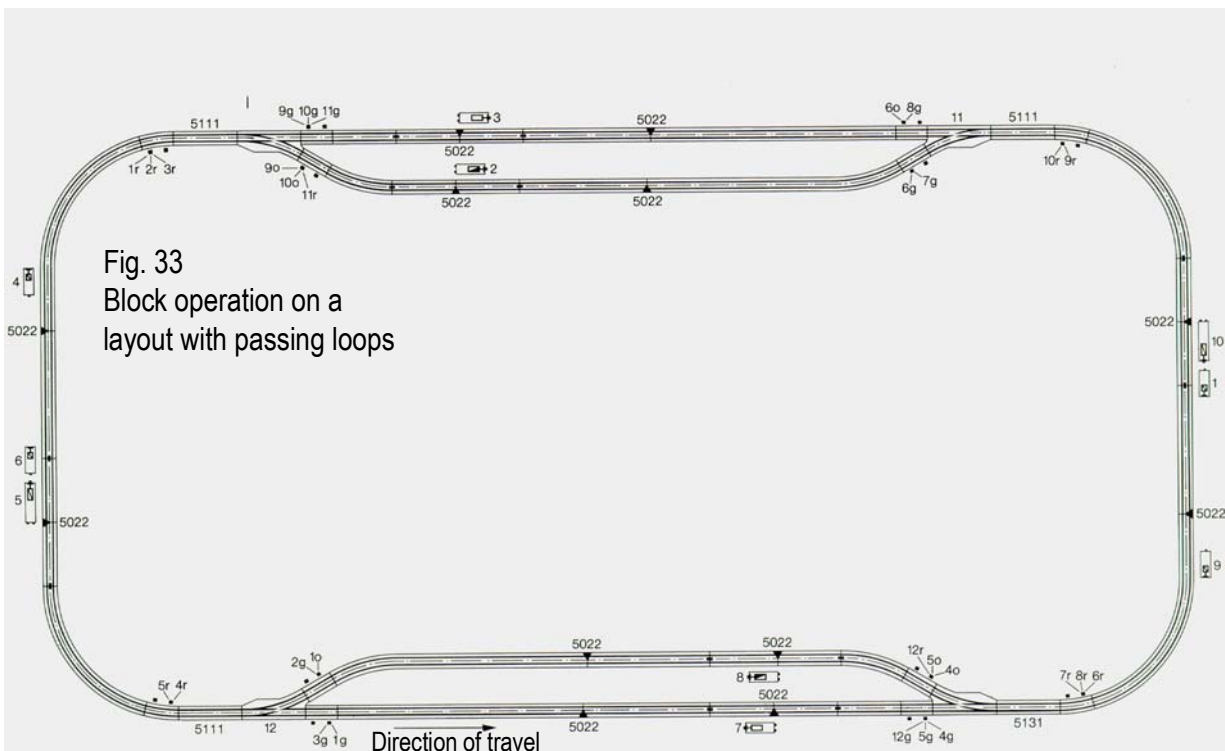
With this layout, shown in fig. 32, it is essential for the distance

between the insulator 5022 on the track center conductor and a switching track section to be greater than the length of the train halting before a signal, so that the train does not come to rest on the switching track section.

### Block operation on a layout with passing loops

The layout shown in fig. 33 is arranged for operation with five trains travelling alternately over the passing loops. In this track plan the system is represented in a very simplified fashion. The signals and the turnouts included in the block system are given serial numbers. Their connections to the appropriate switching track sections have not

been drawn in, but are denoted by numerals and letters. For example, "3 r" denotes that the red plug of signal 3 is to be plugged into this switching track section, "11 g" denote that the green plug of signal 9 and the green plug of turnout 11 are to be plugged into this switching track section. "6 o" means that the orange plug of signal 6 is to be inserted, etc.





## Connecting a home signal with two independent arms to a turnout

This is explained in detail below. In the layout shown in fig. 33, the home signal with independent arms 10 and the turnout numbered 11 affect one another reciprocally. The connections required for this have to be made to the switching track sections behind signals 2 and 3, the switching track section behind **signal 2** receiving the connections 10 o and 11 r and the one behind **signal 3** the connections 10g and 11g. **If a train now travels past signal 2**, it sets signal 10 to "Slow" and turnout 11 to "divert" as it travels

over the switching track section. The incoming train then travels along the clear track until reaching the coupled home signal 2 which has been set at "Halt" in the meantime.

**However, if a train travels past signal 3**, then on passing over the switching track section it sets signal 10 to "Clear" and the turnout 11 to "Straight ahead". The incoming train can now travel along the clear track until reaching signal 3 which has been set to "Halt" in the meantime. The connection between a home signal 7041 and a turnout can also be made as shown in fig. 20.

## Connecting warning signals

These connections are not shown in fig. 29, 30, 31 and 32. Marking them in would make the wiring diagrams difficult to follow. They can however easily be connected by inserting their plugs on the blue leads into the same switching track

sections as the home signals with which they are associated. For example, the switching track section into which the home signal's red plug is inserted will be the switching track section into which the warning signal's red plug will also be inserted.

## Circuits for single-line tracks taking traffic in both directions

For trains travelling in right-hand traffic, only the signals positioned on the right-hand side of the track are valid. The Märklin home signal circuits

however cause trains to be halted by signals set at "Halt" and positioned on the left of the track. This disadvantage can be remedied by the following means:

Fig. 34



1. Appropriate signal arrangement. If signals are installed on single-track lines as shown in fig. 34, with two signals controlling different directions and having a common "dead" section of track, the foregoing drawback is avoided.

2. Current supply via the control panel 7210 or 7211. The relevant circuit is shown in fig. 35. When a train approaching from the right passes over the track, the traction current is supplied to the section

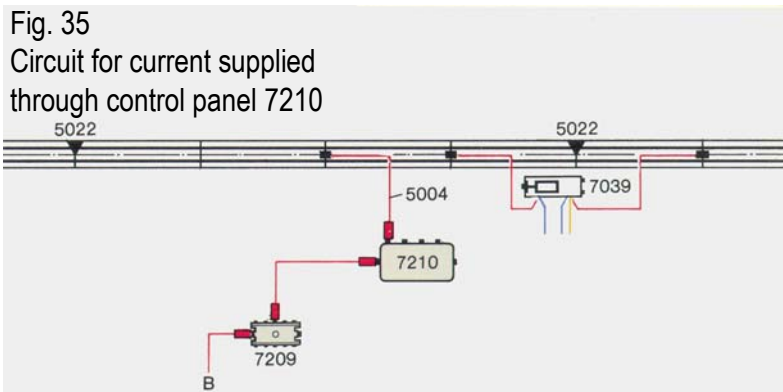




which is isolated from the circuit, via the control panel (through a feeder lead to the track center conductor 5004). The train can thus travel past the signal without the signal being set to "Clear".

universal remote control switch 7245. The example in fig. 39 shows the arrangement of the signal and universal remote control switch, by which train control by the signal on the single-track line is temporarily suspended for trains running in the opposite direction.

3. Current supply through the



## The universal remote control switch 7245

The universal remote control switch (fig. 36) is equipped with two on-off switches and a changeover switch. The switch can be used for a wide variety

Of circuits and control systems. On its cover is a color strip showing which terminals are connected to the same switch.

Fig. 36  
Universal remote control switch 7245



### Basic circuit I:

For switching a current consumer on and off (fig. 38). Operated alternately by coils A and B (fig. 37). A circuit is completed via the path H-J-K or L-M-N. Example: platform lighting is to be switching on by an approaching train before it enters the station and switched off after it has left the station.

### Example (fig. 39):

On a single-track line, the train control action of a signal is to be suspended temporarily for trains in the opposite direction. The signal in the above arrangement can be connected up in the usual way. It does not affect the use of the universal remote control switch.

Fig. 37

The electrical operation of the universal remote control switch

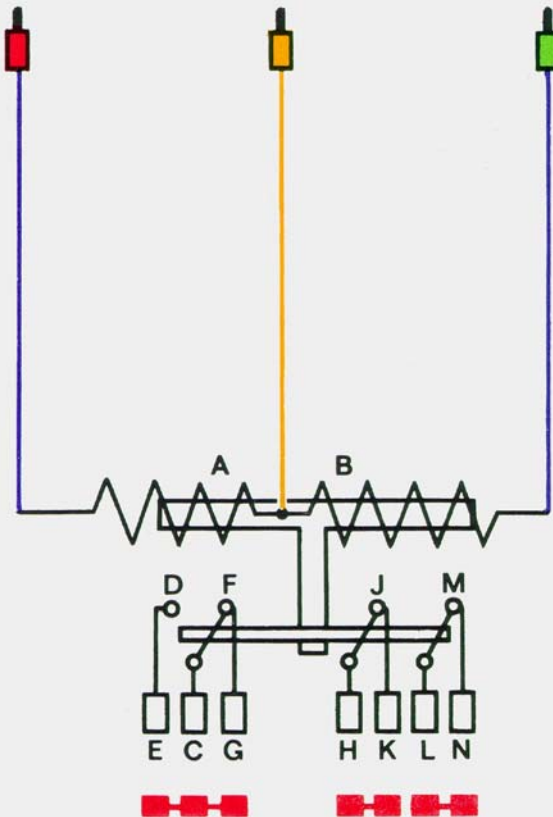
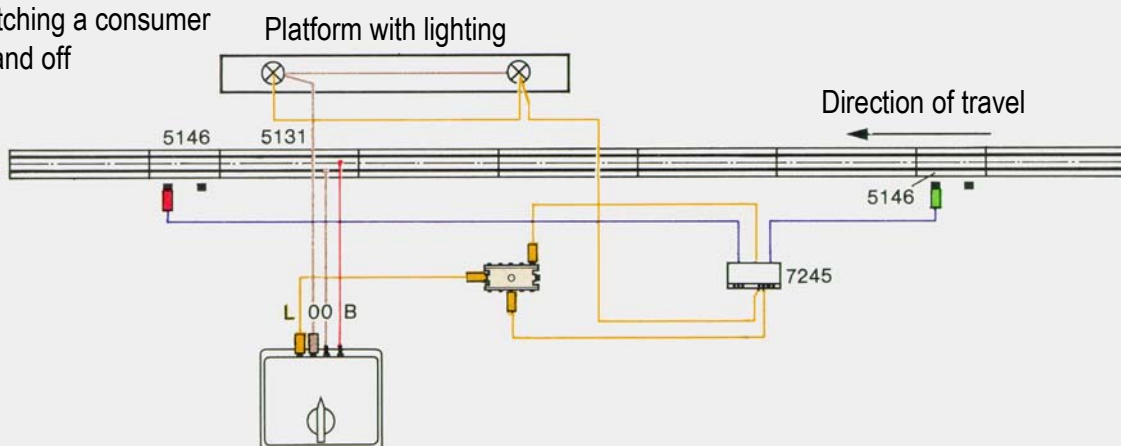


Fig. 38

Switching a consumer on and off



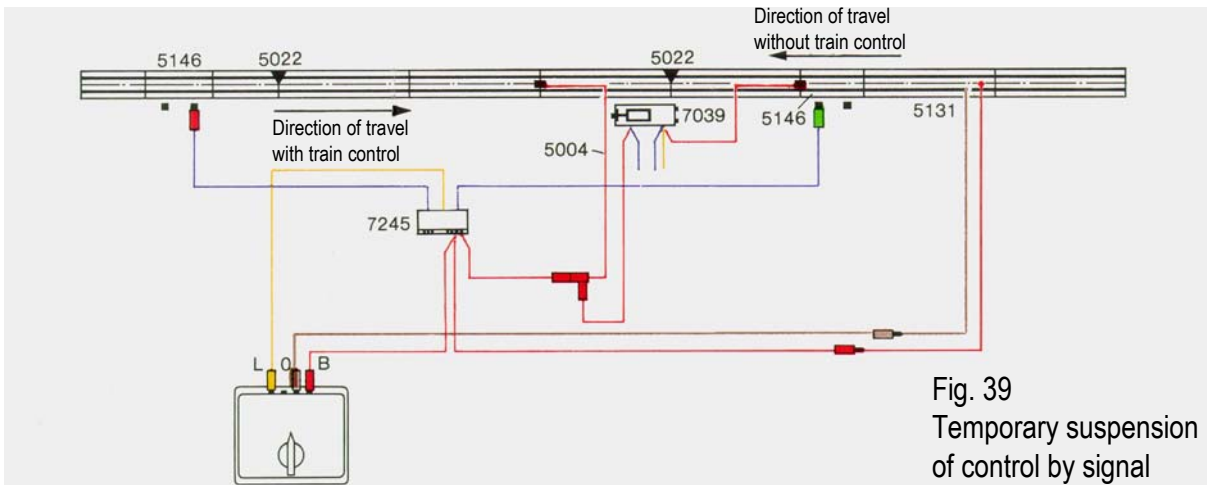


Fig. 39  
Temporary suspension  
of control by signal

Basic circuit II:  
Alternating switch-over of two consumers on one current source. Operated alternately by coils A and B. Switching over current circuit C, D, E to current circuit C, F, G with current supply at C and current consumption at E or G (fig. 37). Example (fig. 40):

A train arriving from A is to enter either track C or B. The next train is then to enter the clear track and a third train is to be directed to the first track again. For this purpose the turnout is connected to the terminals of a universal remote control switch 7245 and the switch is also connected by another lead to the switching

track section S3. With this arrangement the incoming train sets the turnout in the predetermined direction. The universal remote control switch is switched over by switching track section S 1 or S 2, thereby pre-selecting the setting of the turnout for the next train which arrives.

Fig. 40  
Automatic switching of incoming trains to one of two or more station tracks by pre-selection with the aid of a universal remote control switch

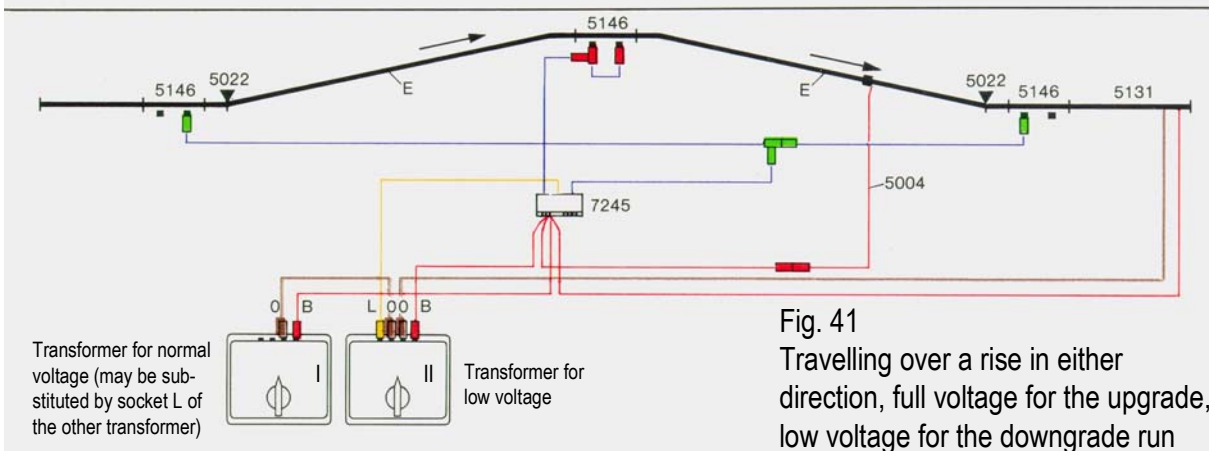
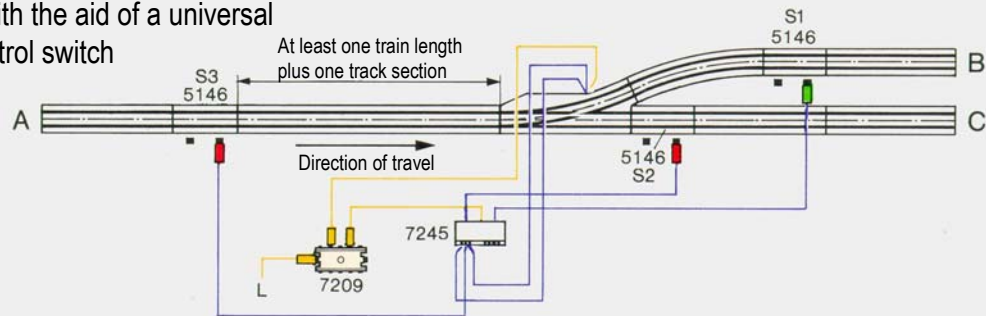


Fig. 41  
Travelling over a rise in either  
direction, full voltage for the upgrade,  
low voltage for the downgrade run

Basic circuit III:  
 Alternating switch-over of two current sources to one consumer. Alternating operation by coils A and B. Switching between circuits E, D, C and G, F, C with current supply at E or G and consumption at C (fig. 37).

Example (fig. 41):  
 When crossing a rise, the train itself switches on the full traction voltage for the upgrade journey and the low voltage for the down-grade run. The traction current from transformer I is supplied to the universal remote control switch via terminal E and that from

transformer 11 via terminal G. The terminal C of the remote control switch is connected to the isolated track section E and through the universal remote control switch to transformer I for the upgrade run and to transformer 11 for the downgrade run. The transformers are adjusted in this case so that the voltage from transformer 11 is lower than that from transformer 1. These low-speed sections give the model railroad system a touch of realism closely related to its full-scale counterpart. Use is made of the train's full power for the upgrade run and accidents are avoided during the downgrade run. This circuit functions regardless of the direction of travel of the train, i.e. whether the train runs from right to left or from left to right.

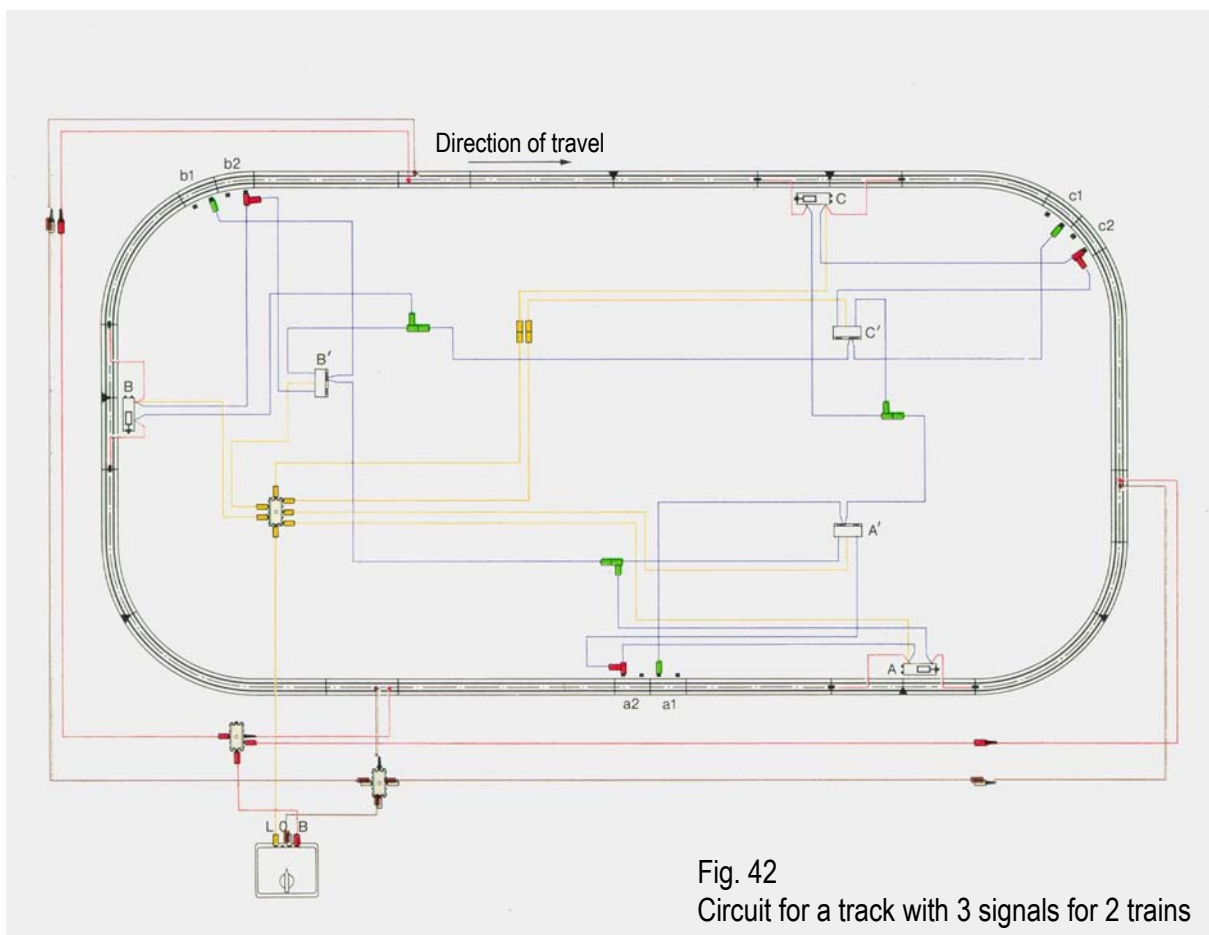


Fig. 42  
 Circuit for a track with 3 signals for 2 trains

Many different combinations can be assembled by making use of the basic circuits which have been described. Finally, a description is given of a circuit which enables trains of very different types to operate over complex layouts (also including long gradients).

For example, it is possible with this circuit for a long, slow freight train to run in front of a short, fast railcar without risk of collision. This circuit constitutes a doubly safeguarded block system.

The circuit shows a track with three signals for two trains. The trains travel clockwise. Each signal covers two switching track sections and one universal remote control switch. The circuits for the control of the trains (the traction current) by the signals are quite normal. The first switching track section is connected to the switch by the red lead (voltage feed), the second switching track section to the signal and the switch by the red plugs. The green plugs are connected to the switch on the following signal. The system operates as follows:

A train halts at signal B (signal at "Halt", remote switch red), signal A is also at "Halt". Signal C is "Clear" (remote switch green) and a train passes signal C. As it does so it passes over switching track section  $c_1$  and thereby supplies current to switch C'. As this switch is connected in parallel with signal C, i.e. also set at green, the current is passed on direct to signal B, which, together with the remote switch, changes to green.

The train at B moves off. In the meantime the train at C passes the switching track section  $c_2$  and sets signal C and remote switch C' to red. The train at B during this time has switched the signal A to green, as described above. If the train coming from B is very fast (as compared with the one coming from C), it must stop at C until the other train has passed A and cleared C. If on the other hand the train from B is very slow, it will not have reached C by the time the other train has already passed A and thereby switched C back to green. However, as B can only be set at "Clear" by 0, the fast train must halt at B until the slow train has passed C. In this way the slow train is always separated from the train behind it by the distance between signals. This system can be extended as required, but as with the normal block system, there must always be one signal more than the number of trains operating.

The advantage of this circuit over other forms of block section safeguards is primarily in the fact that only a brief pulse is given to trigger the setting of the signal to "Clear" as a train passes over switching track sections  $a_1$ ,  $b_1$ , and  $c_1$ . As soon as the train reaches the next switching track sections  $a_2$ ,  $b_2$  or  $c_2$ , the pulse is interrupted. The signal in question can therefore be switched immediately to "Halt". With the usual type of block safeguarding, this is only possible after the train in front has completely cleared the switching track section. The layout shown in fig. 42 therefore ensures greater protection against unauthorized overrunning of a signal.

Furthermore, the circuit in question will prevent signals being set at "Clear" and "Halt" in quick succession. This is liable to occur with the conventional block system, depending on which of the switching track sections serving a particular signal is being passed over by the train at a given moment.

In conclusion it may be said that by observing the basic examples and rules described here, no difficulty will be experienced in equipping even the more ambitious types of track layouts with the Märklin block system. These circuits will crop up again and again, either individually or in combination with others.

This is one of the most attractive features of automatic circuits: in addition to layout planning, to be able also to design the signal arrangements and to demonstrate the efficiency of the layout by realistic operation and control of the trains by the signals. Anyone who has taken the first steps in this direction and taken a closer look at the factors involved, will have no hesitation in progressing still further and expanding his system accordingly. The pleasure to be derived from this hobby increases in line with the degree of realism which can be achieved in the operation of the system and here is where the Märklin block system offers a guarantee of complete success.

